



ACE17409B

P-Channel Enhancement Mode Power MOSFET

Description

- Backlighting
- Power Management Functions
- DC-DC Converters

Features

- $V_{DS} = -30V$
- $I_D = -36A$
- $R_{DS(ON)} @ V_{GS} = -10V, TYP 11 m\Omega$
- $R_{DS(ON)} @ V_{GS} = -4.5V, TYP 17 m\Omega$

Absolute Maximum Ratings

Parameter		Symbol	Ratings	Units
Drain-Source Voltage		V_{DSS}	30	V
Gate-Source Voltage		V_{GSS}	± 20	V
Drain Current(Continuous) ^{*AC}	$T_C = 25^\circ C$	I_D	-36	A
	$T_C = 70^\circ C$		-29	
Drain Current(Pulsed) ^{*B}		I_{DM}	-144	A
Power Dissipation	$T_C = 25^\circ C$	P_D	30	W
Operating temperature / storage temperature		T_J / T_{STG}	-55~150	$^\circ C$

Thermal Resistance Ratings

Parameter		Symbol	Typical	Maximum	Units
Maximum Junction-to-Ambient	$t \leq 10 s$	R_{thJA}	30	40	$^\circ C/W$
Maximum Junction-to-Lead	Steady State	R_{thJC}	3.5	4.2	



ACE17409B

P-Channel Enhancement Mode Power MOSFET

Packaging Type

PDFN3*3-8L

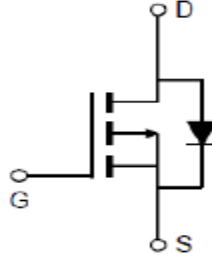
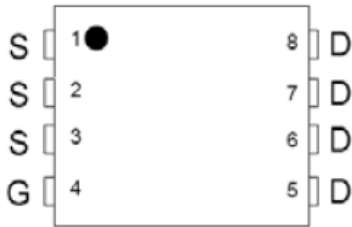

Ordering information

ACE17409B XX + H

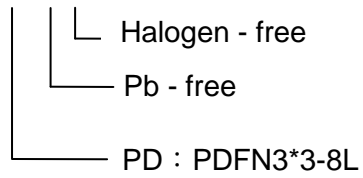



ACE17409B

P-Channel Enhancement Mode Power MOSFET

Electrical Characteristics

T_A=25°C, unless otherwise specified.

Parameter	Symbol	Test Conditions	Min	Typ	Max	Unit
Static						
Drain-Source Breakdown Voltage	V _{(BR)DSS}	V _{GS} = 0V, I _D = -250 uA	-30			V
Zero Gate Voltage Drain Current	I _{DSS}	V _{DS} = -30 V, V _{GS} = 0V			-1	uA
Gate Threshold Voltage	V _{GS(TH)}	V _{GS} = V _{DS} , I _{DS} = -250 uA	-1	-1.6	-3	V
Gate Leakage Current	I _{GSS}	V _{GS} = ±20 V, V _{DS} = 0V			±100	nA
Drain-Source On-state Resistance	R _{DS(on)}	V _{GS} = -10 V, I _D = -7 A		11	15	mΩ
		V _{GS} = -4.5 V, I _D = -10A		17	22	
Diode Forward Voltage	V _{SD}	I _{SD} =-1A, V _{GS} = 0 V			-1	V
Diode Forward Current	I _S	TC=25°C			-36	A
Switching						
Total Gate Charge	Q _g	V _{GS} = -10 V, V _{DS} = -15V, I _D = -9 A		30		nC
Gate-Source Charge	Q _{gs}			4.6		
Gate-Drain Charge	Q _{gd}			10		
Turn-On Delay Time	t _{d(on)}	V _{GS} = -10V, V _{DS} =-15V, R _L = 1.6Ω, R _{GEN} = 3Ω		11		ns
Turn-On Rise Time	t _r			9.4		
Turn-Off Delay Time	t _{d(off)}			24		
Turn-Off Fall Time	t _f			12		
Dynamic						
Input Capacitance	C _{iss}	V _{DS} = -15V, V _{GS} =0V, f=1.0MHz		2060		pF
Output Capacitance	C _{oss}			370		
Reverse Transfer Capacitance	C _{rss}			295		

Note :

- The value of R_{θJA} is measured with the device mounted on 1in2 FR-4 board with 2oz. Copper, in a still air environment with TA=25°C. The value in any given application depends on the user's specific board design.
- Repetitive rating, pulse width limited by junction temperature.
- The current rating is based on the t ≤ 10s junction to ambient thermal resistance rating



ACE17409B

P-Channel Enhancement Mode Power MOSFET

Typical Performance Characteristics

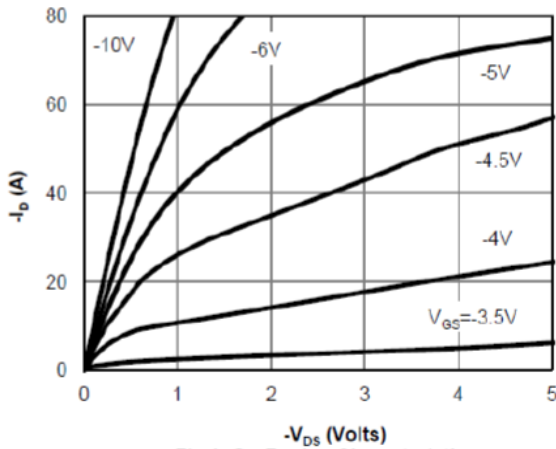

Fig 1: On-Region Characteristics

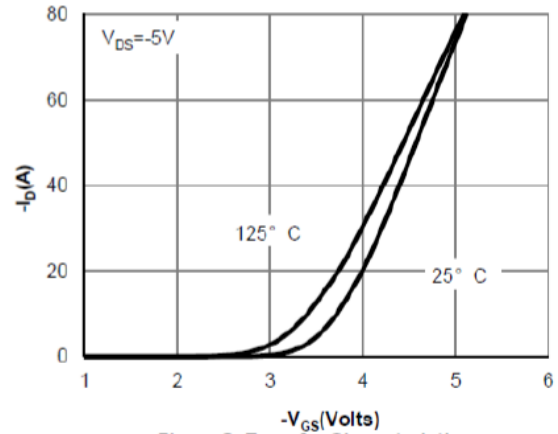

Figure 2: Transfer Characteristics

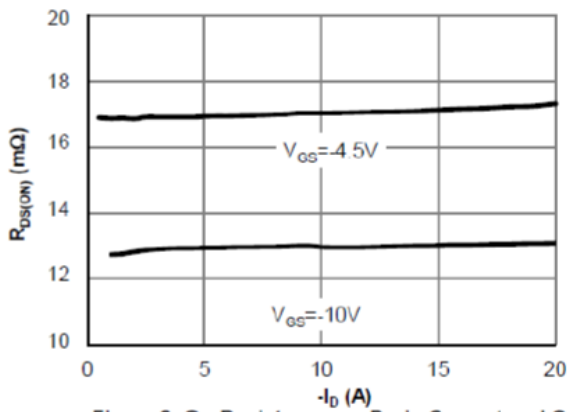

Figure 3: On-Resistance vs. Drain Current and Gate Voltage

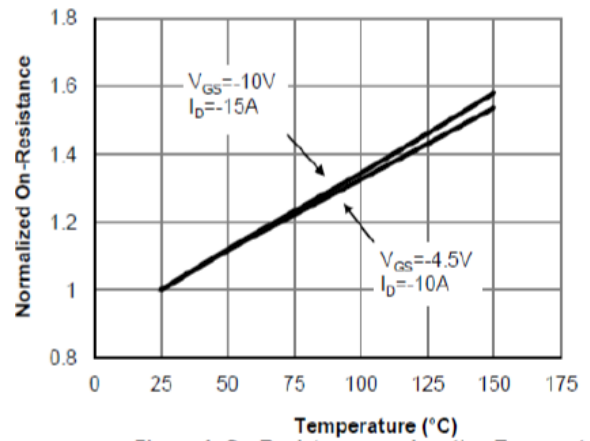

Figure 4: On-Resistance vs. Junction Temperature

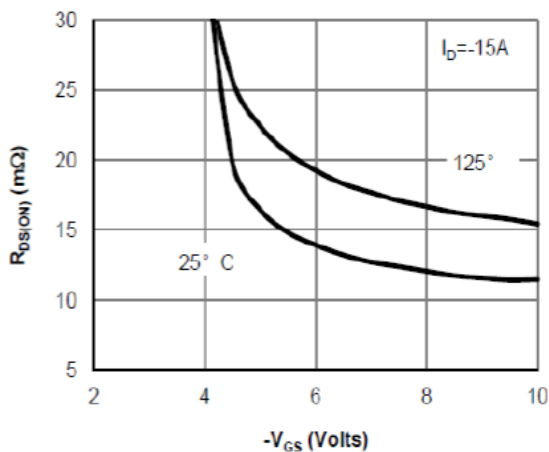

Figure 5: On-Resistance vs. Gate-Source Voltage

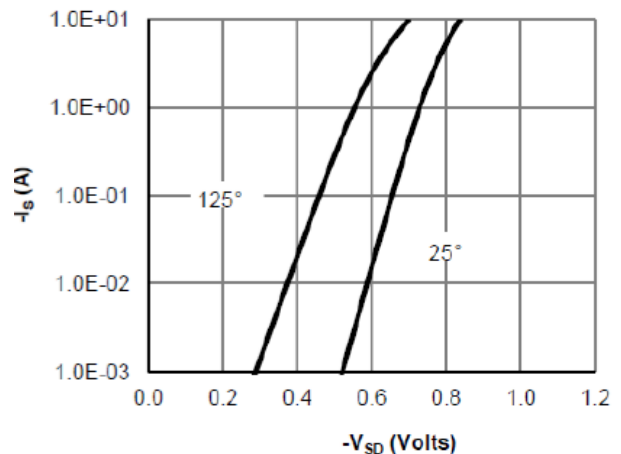

Figure 6: Body-Diode Characteristics



ACE17409B

P-Channel Enhancement Mode Power MOSFET

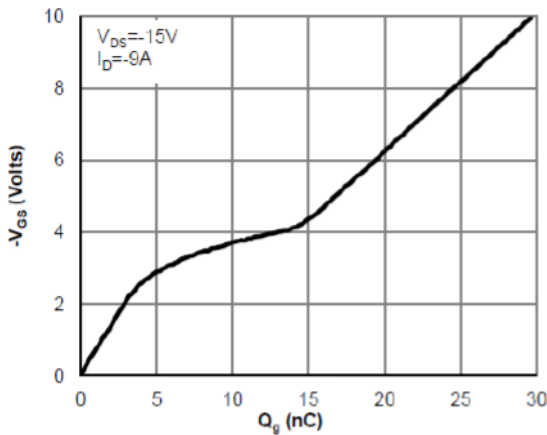

Figure 7: Gate-Charge Characteristics

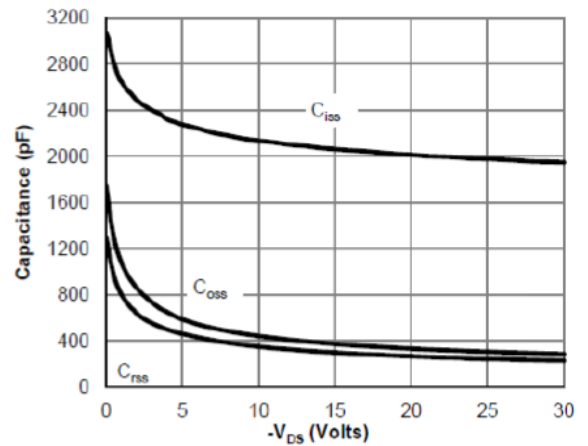

Figure 8: Capacitance Characteristics

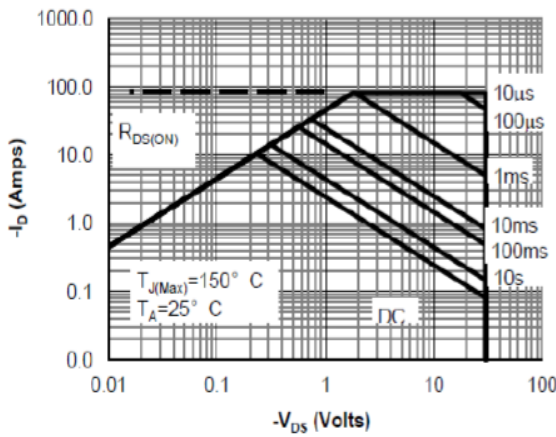

Figure 9: Maximum Forward Biased Safe Operating Area

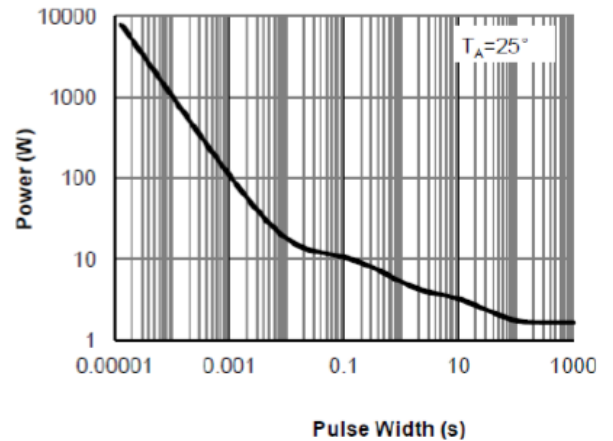

Figure 10: Single Pulse Power Rating Junction-to-Ambient

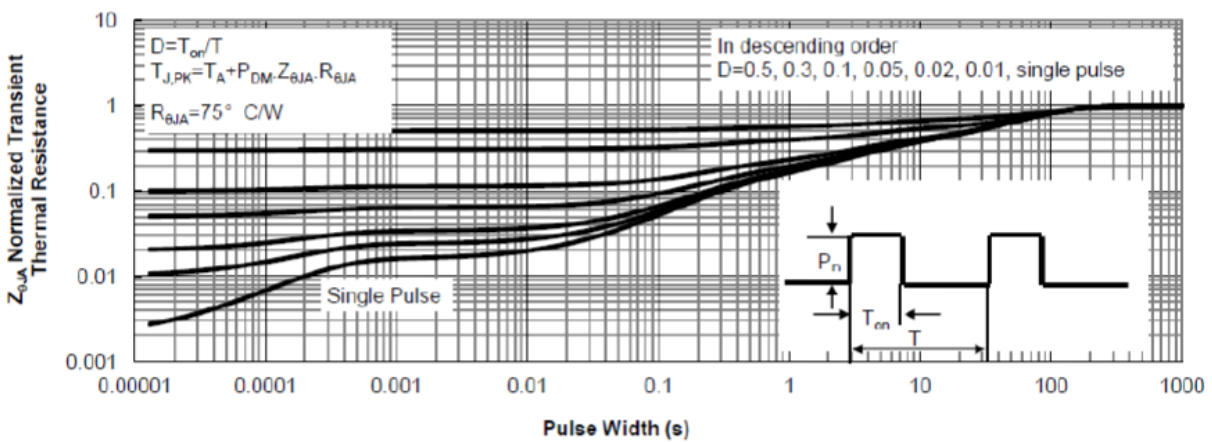

Figure 11: Normalized Maximum Transient Thermal Impedance



ACE17409B

P-Channel Enhancement Mode Power MOSFET

Packing Information

PDFN3*3-8L

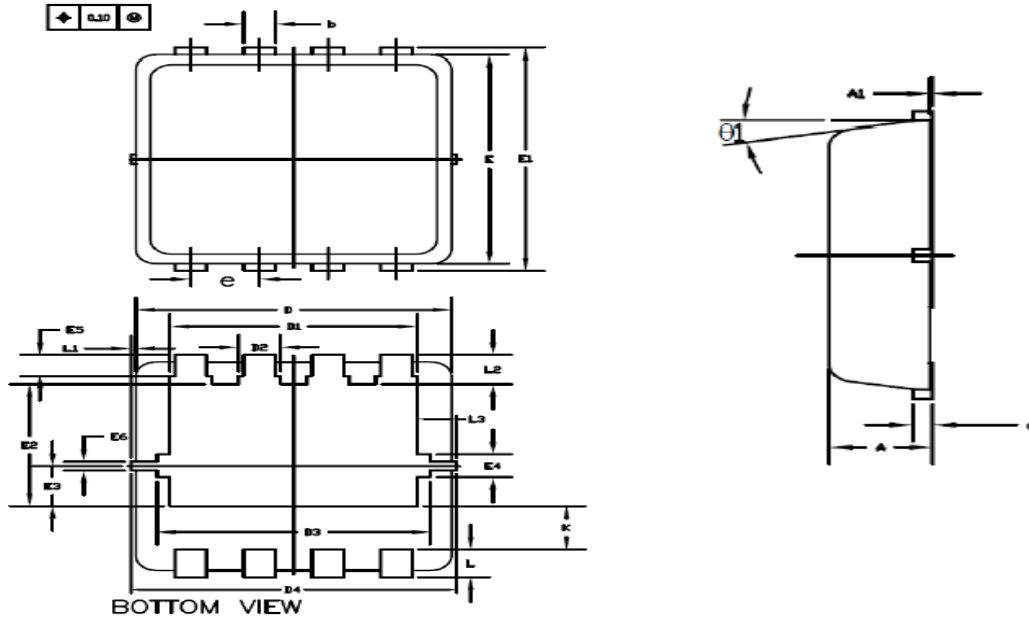

RECOMMENDED LAND PATTERN

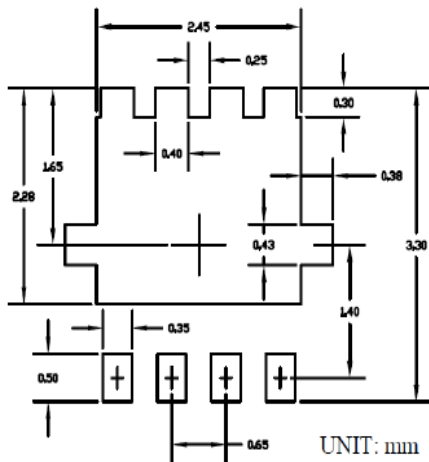

Symbol	Dimensions In Millimeters			Dimensions In Inches		
	Min	Nom	Max	Min	Nom	Max
A	0.700	0.800	0.900	0.028	0.031	0.035
A1		0.025	0.050		0.001	0.002
b	0.240	0.300	0.350	0.009	0.012	0.014
c	0.100	0.150	0.250	0.004	0.006	0.010
D	2.900	3.000	3.100	0.114	0.118	0.122
D1	2.250	2.350	2.450	0.089	0.093	0.097
D2	0.300	0.400	0.500	0.012	0.016	0.020
D3	2.500	2.600	2.700	0.098	0.102	0.106
D4	3.000	3.100	3.200	0.118	0.122	0.126
E	2.900	3.000	3.100	0.114	0.118	0.122
E1	3.100	3.200	3.300	0.122	0.126	0.130
E2	1.650	1.750	1.850	0.065	0.069	0.073
E3	0.480	0.580	0.680	0.019	0.023	0.027
E4	0.230	0.330	0.430	0.009	0.013	0.017
E5	0.200	0.300	0.400	0.008	0.012	0.016
E6	0.075	0.125	0.175	0.003	0.005	0.007
e	0.600	0.650	0.700	0.024	0.026	0.028
K	0.520	0.620	0.720	0.020	0.024	0.028
L	0.300	0.400	0.500	0.012	0.016	0.020
L1		0.050	0.100		0.002	0.004
L2	0.330	0.430	0.530	0.013	0.017	0.021
L3	0.275	0.375	0.475	0.011	0.015	0.019
θ	0°	10°	12°	0°	10°	12°

NOTE

1. PACKAGE DIMENSION IS EXCLUSIVE OF MOLD GATE BURR
2. PACKAGE DIMENSION IS EXCLUSIVE OF MOLD FLASH AND CUTTING BURR
3. CONTROLLING DIMENSION IS MILLIMETER.
CONVERTED INCH DIMENSIONS ARE NOT NECESSARILY EXACT.



ACE17409B

P-Channel Enhancement Mode Power MOSFET

Notes

ACE does not assume any responsibility for use as critical components in life support devices or systems without the express written approval of the president and general counsel of ACE Electronics Co., LTD.

As used herein:

1. Life support devices or systems are devices or systems which, (a) are intended for surgical implant into the body, or (b) support or sustain life, and whose failure to perform when properly used in accordance with instructions for use provided in the labeling, can be reasonably expected to result in a significant injury to the user.
2. A critical component is any component of a life support device or system whose failure to perform can be reasonably expected to cause the failure of the life support device or system, or to affect its safety or effectiveness.

ACE Technology Co., LTD.
<http://www.ace-ele.com/>